

SURFACE MOUNT BOX

1 Port (CAT5E Jack)



DESCRIPTION

1 Port Surface Mount Box with a CAT5E built in jack.

FEATURES

- High-impact ABS construction
- Screws, ties and adhesive tape included
- 110 & Krone type compatible
- UL 94 V-0 Fire Retardant
- Gloss finish
- UL listed



Available in White and Ivory

SKU: 038 SERIES (CAT5E Jack)

Material:

1. Case : ABS, UL 94V-10
2. RJ45 Jack Housing: PBT+Glass Fiber, UL 94V-0 (Black)
3. Contact Bracket: PBT+Glass Fiber, UL 94V-0 (Black)
4. RJ45 Jack Contact
Material: Phospor Bronze with Nickel plated
Finish: 50 micro-inch Gold plated on plug contact area
5. IDC
IDC Housing: PC+Glass Fiber, UL 94V-2
IDC Terminal: Phospor Bronze with Tin plating.
6. Screw: M2.0x6.0xø3.3mm
7. PCB: FR4, UL 94V-0
8. Screw: M3.5x16.0xø6.0mm

Performance

T568A & T568B wiring printing on IDC.
Insertion force: 20N max (IEC 60603-7-4)
Retention Strength : 7.7 kg between Jack and Plug
Operating temperature: -10°C to 60°C
(ISO/IEC 11801, ANSI/TIA/EIA 568 B.2)

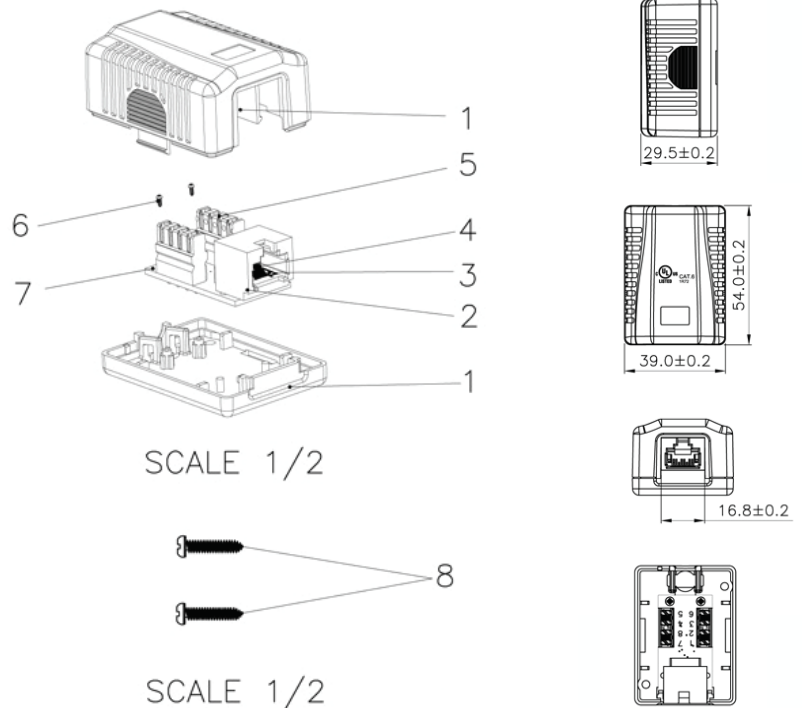

VERTICAL CABLE

954 454-3554 Florida Office

951 696-7772 California Office



www.verticalcable.com

Rev. 10/2016

Subject to change without notice.